

THE ORIGINAL
REXALLOY®™

HOMOGENIZER & HIGH PRESSURE PUMP REPLACEMENT PARTS



PROVING THEMSELVES RELIABLE FOR OVER FOUR DECADES

- *INCOMPARABLE WEAR RESISTANCE UNDER HEAVY SERVICE*
- *SUPERIOR CORROSION EROSION RESISTANCE DURING SANITIZING PROCEDURES*
- *THE INDUSTRY'S BENCHMARK FOR HIGH PERFORMANCE IN SANITARY FOOD CONTACT COMPONENTS*
- *MANUFACTURED WITH THE HIGHEST STANDARDS TO GUARANTEE THE QUALITY YOU HAVE COME TO EXPECT*

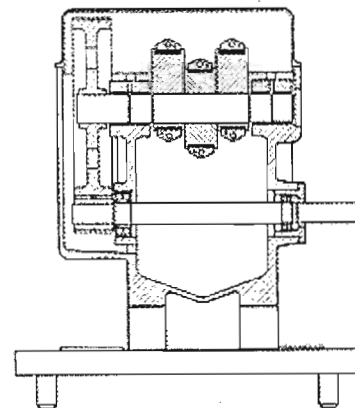
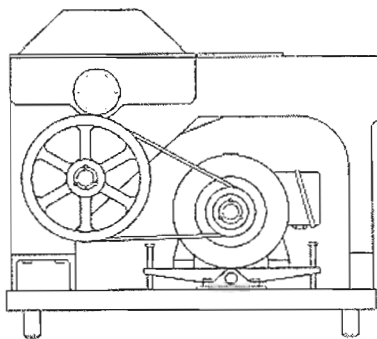

Part Number Prefix Descriptions :

TS = Triangular Valve Seat (Pilot Valve Seat)

TV = Triangular Valve (Pilot Valve)

S = One Step Seat (Plug/Dynojet Valve Seat)

SS = Two Step Seat (Plug/Dynojet Valve Seat)

PV = Plug Valve (Dynojet Valve)

IR = Impact Ring (For Both Plug and Pilot Valve Types)

PVS = Poppet Valve Seat

BVS = Ball Valve Seat



REXALLOY®™ Pilot Type Homogenizer Valves & Seats

<u>Pilot Size</u>	<u>Comp. Seat No.</u>	<u>REXALLOY®™ P.N.</u>	<u>Comp. Valve No.</u>	<u>REXALLOY®™ P.N.</u>
3/8"	124206	TS602421	125207	TV702521
5/8"	124207	TS702421	125208	TV802521
7/8"	124303	TS303421	125304	TV403521
1-1/2"	124407	TS704421	125420	TV024521
1-1/2"	124416	TS614421	125420	TV024521
2"	124422	TS224421	125419	TV914521
2"	124423	TS324421	125419	TV914521
2"	124440	TS044421	125419	TV914521
2"	124443	TS344421	125419	TV914521

ITEMS CAN BE ORDERED INDIVIDUALLY, HOWEVER MATCHED SETS OF VALVE AND SEAT ARE RECOMMENDED

REXALLOY[®]™ DYNO JET/HOMOGENIZER VALVE



REXALLOY[®]™ Homogenizer Valves (Plug/Dynojet Type)

Size	Comparable P.N.	REXALLOY [®] ™ P.N.	Style
3/8"	125115	PV5115	FLUTED
13/16"	125316	PV6135	FLUTED
1-1/8"	125416	PV6145	FLUTED
1-3/8"	125413	PV3145	FLUTED

3/8"	125105	PV5015	GROOVED
13/16"	125204	PV4025	GROOVED
1-1/8"	125415	PV5145	GROOVED
1-3/8"	125417	PV7145	GROOVED

3/8"	125100	PV0015	STRAIGHT
5/8"	125200	PV0025	STRAIGHT
13/16"	125300	PV0035	STRAIGHT
1-1/8"	125400	PV0045	STRAIGHT
1-3/8"	125403	PV3045	STRAIGHT



REXALLOY[®]™ DYNO JET/ HOMOGENIZER VALVE SEATS

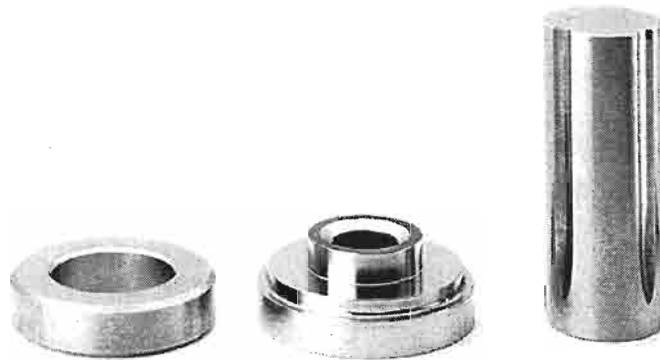

REXALLOY[®]™ Homogenizer SEATS (Plug/Dynojet Type)

<u>Size</u>	<u>Comparable Seat P.N.</u>	<u>REXALLOY[®]™ P.N.</u>	<u>Seat Style</u>
3/8"	124100	S001421	ONE STEP
5/8"	124200	S002421	ONE STEP
13/16"	124201	S102421	ONE STEP
1-1/8"	124415	S514421	ONE STEP
1-3/8"	124403	S304421	ONE STEP
1-3/8"	124404	S404421	ONE STEP
3/8"	124120	SS021421	TWO STEP
13/16"	124234	SS432421	TWO STEP
13/16"	124235	SS532421	TWO STEP
1-1/8"	124439	SS934421	TWO STEP
1-1/8"	124464	SS464421	TWO STEP
1-3/8"	124434	SS344421	TWO STEP
1-3/8"	124435	SS534421	TWO STEP

MATCH THESE SEATS TO APPROPRIATE PLUG VALVE



PUMP (POPPET) VALVE SEATS - Suction & Discharge

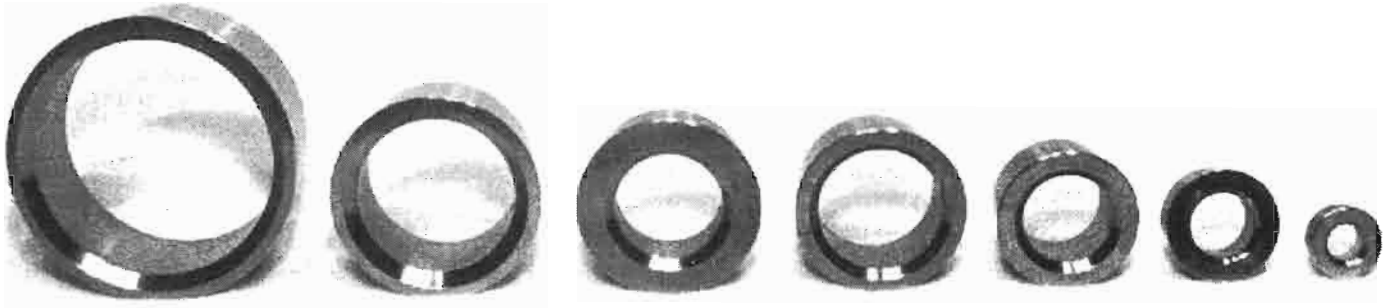

REXALLOY®™ PUMP VALVE SEATS

<u>Pilot Diameter</u>	<u>Comparable Part No.</u>	<u>REXALLOY®™ P.N.</u>
3/4"	036707	PVS707630
7/8"	036710	PVS017630
1-3/8"	036713	PVS317630
1-7/8"	036716	PVS617630
2-3/8"	036719	PVS917630
2-7/8"	036722	PVS227630
2-7/8"	036729	PVS927630
3-5/8"	036730	PVS037630

REXALLOY[®]™ BALL VALVE SEATS
Suction & Discharge



REXALLOY[®]™ PUMP VALVE SEATS

<u>For Ball Diameter</u>	<u>Comparable P.N.</u>	<u>REXALLOY[®]™ P.N.</u>
7/8"	036123	BVS321630
1-1/4"	036506	BVS605630
1-1/4"	036479	BVS974630
1-1/2"	036446	BVS644630
1-1/2"	036455	BVS554630
1-1/2"	036476	BVS674630
1-1/2"	036478	BVS874630
2"	036509	BVS905630
2-1/2"	036704	BVS407630

REXALLOY[®]™ 35 BALL VALVES

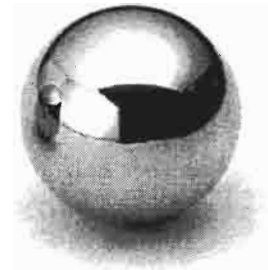
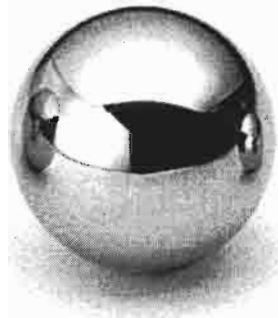

<u>Ball Diameter</u>	<u>Comparable P.N.</u>	<u>REXALLOY[®]™ P.N.</u>	<u>Use Seat No.</u>
7/8"	035103	.875BALL	036123
1-1/4"	035104	1.25BALL	036506
1-1/4"	035104	1.25BALL	036479
1-1/2"	035105	1.50BALL	036446
1-1/2"	035105	1.50BALL	036455
1-1/2"	035105	1.50BALL	036476
1-1/2"	035105	1.50BALL	036478
2"	035112	2.00BALL	036509
2-1/2"	035111	2.50BALL	036704

* NOTE : 5/8" Diameter Ball Also Available - Part No. .625BALL (035102)

PUMP VALVES - POPPET TYPE SUCTION & DISCHARGE



- Certified Stainless Steel Type 17-4-pH
 - Cast AMS-5355-F Specification Quality
 - Solution Annealed & Precipitation Hardened

<u>Size</u>	<u>Poppet/Pump Valve No.</u>	<u>Use Seat No.</u>
3/4"	035100	036707
3/4"	035134/035100	036707
3/4"	035136	036707
7/8"	035200	036710
7/8"	035215	036710
1-3/8"	035226/035608	036713
1-3/8"	035607	036713
1-3/8"	035608	036713
1-3/8"	035857	036713
1-7/8"	035227/035858	036716
1-7/8"	035609/035858	036716
1-7/8"	035814	036716
1-7/8"	035858	036716
2-3/8"	035313/035854	036719
2-3/8"	035812/035854	036719
2-3/8"	035815/035854	036719
2-3/8"	035854	036719
2-7/8"	035314/035816	036722
2-7/8"	035806/035816	036722
2-7/8"	035816	036722
2-7/8"	035853/035816	036722

BALL VALVE GUIDE RETROFIT REPLACEMENTS

- More sanitary *SINGLE INTEGRAL PART*
- Provides more flow through in high viscosity applications than traditional guides
- Increased service life and reduced costs

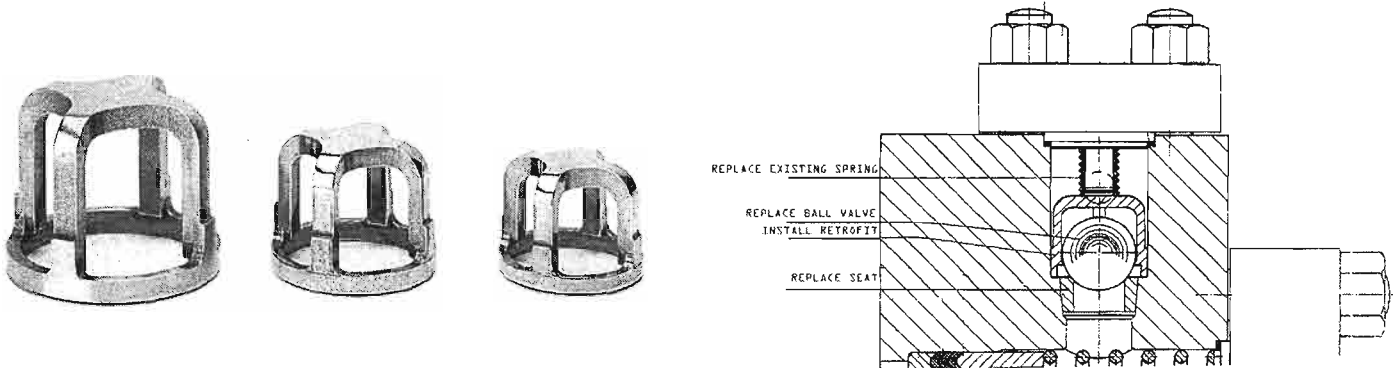

7/8" SIZE Part Number T20702

USES SEAT - 036123 & 035103 Ball Valve
For - M3-3/5 - 8 TBS & M6/M12-8 TBS

REPLACES: APV-037107 GUIDE
APV-033110 STOP

1-1/4" SIZE Part Number T20703

USES SEAT - 036506 & 035104 Ball valve
For - M6/M12-5 TBS & MC/MS 18-8 TBS

REPLACES: APV-037504 GUIDE
APV-033207 STOP

1-1/2" SIZE Part Number T20704

USES SEAT - 036446 & 035105 Ball Valve
For - M6/M12-2/3 TBS, MC/MS18-5 TBS, MC/MS45-8 TBS

REPLACES: APV-037431 GUIDE
APV-033310 STOP

2" SIZE Part Number T20705

USES SEAT - 036509 & 035112 Ball Valve
For - MC/MS18-2/2, 5/3 TBS, MC/MS45-4/5 TBS

REPLACES: APV-037506 GUIDE
APV-033432 STOP

REXALLOY[®]™ MICRO-GAP VALVES & BASE PLATES



Comparable Part No.

899594

899666

899667

899776

REXALLOY[®]™ P.N.

MG495998

MG666998

MG766998

MG677998

MICROGAP MATCH-UP'S

Small Valve	899666 / MG 666998
Small Base	899667 / MG766998
Large Valve	899594 / MG495998
Large Base	899776 / MG677998

REXALLOY[®]™ *IMPACT RINGS*

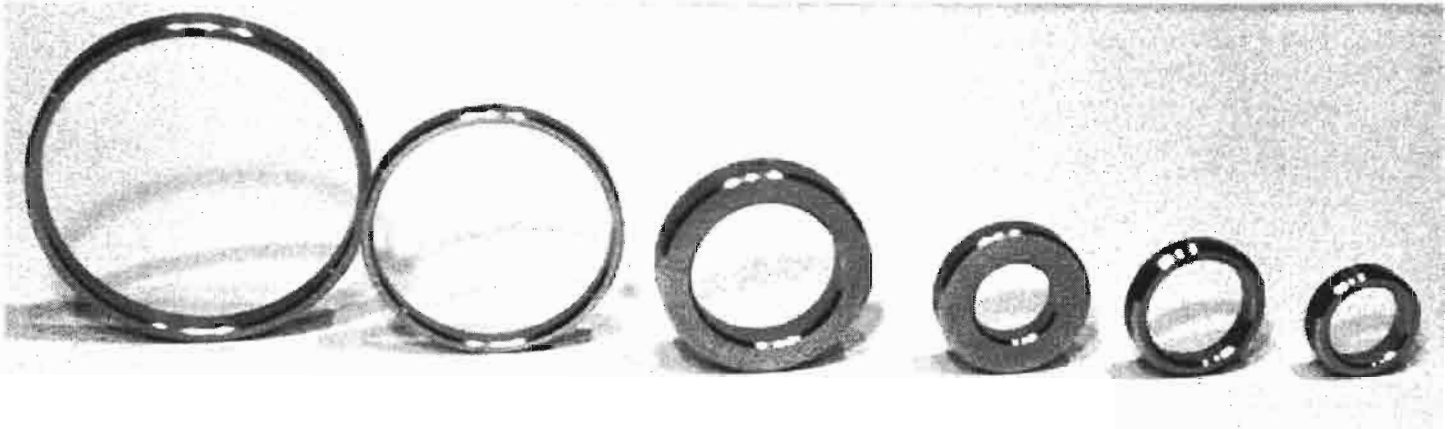

Comparable Part No.

REXALLOY[®]™ Part No.

I26100	IR00162I
I26107	IR70162I
I26117	IR71162I
I26201	IR10262I
I26207	IR70262I
I26209	IR90262I
I26215	IR51262I
I26217	IR71262I
I26220	IR02262I
I26222	IR22262I
I26304	IR40362I
I26404	IR40462I
I26406	IR60462I
I26407	IR70462I
I26409	IR90462I
I26417	IR71462I
I26418	IR81462I
I26421	IR12462I
I26428	IR82462I
I26431	IR13462I
I26434	IR43462I
T22410	SAME
T22412	SAME
T22416	SAME
T22419	SAME
T22420	SAME
T22444	SAME

(OTHER SIZES AVAILABLE - PLEASE ASK IF YOU DO NOT SEE IT LISTED HERE)

ALL SIZE PLUNGERS & PLUNGER RINGS

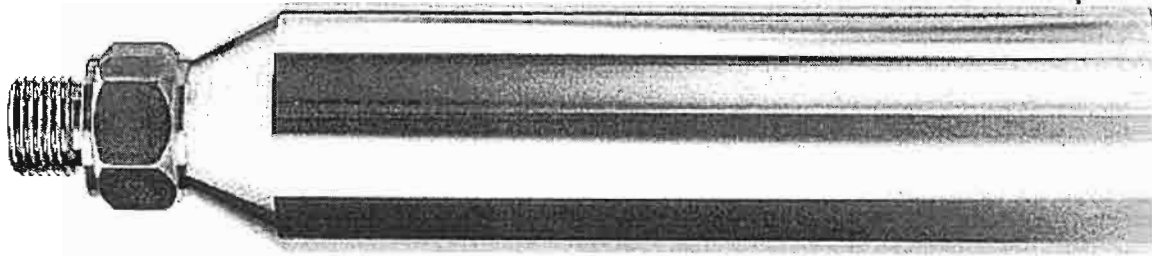

Stainless Steel Type 316 & Type 17-4-pH

All Diameters & Lengths

1.1875" RD. - 1.375" RD. - 1.4375" RD. - 1.500" RD. - 1.750" RD.
2.125" RD. - 2.500" RD. - 2.750" RD. - 3.000" RD. - 3.125" RD
(PLEASE CALL WITH YOUR SPECIFIC PART NUMBER OR SIZE)

ADAPTER RODS

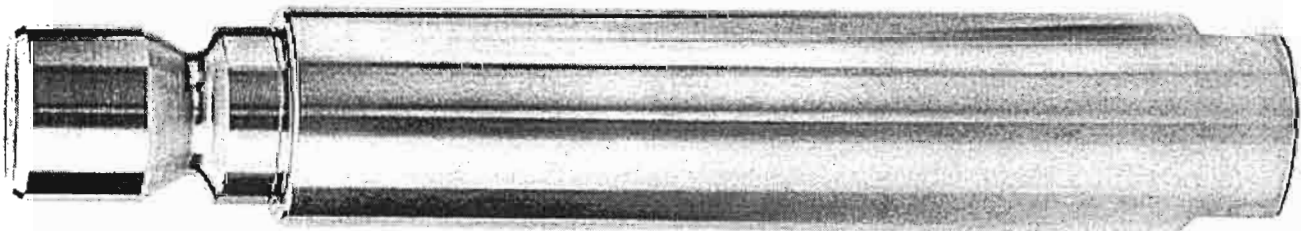

PACKING ADJUSTING RINGS

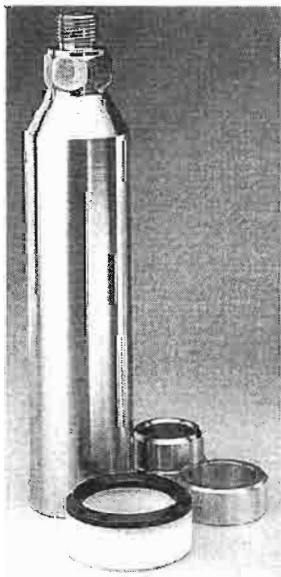

STUDS

***MOST ITEMS ARE IN STOCK
ALLOW (7-10) DAYS FOR ANY ITEM THAT
REQUIRES PRODUCTION***

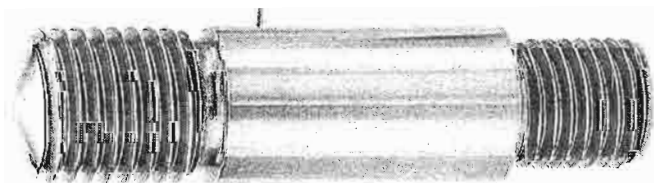

CYLINDER BLOCKS

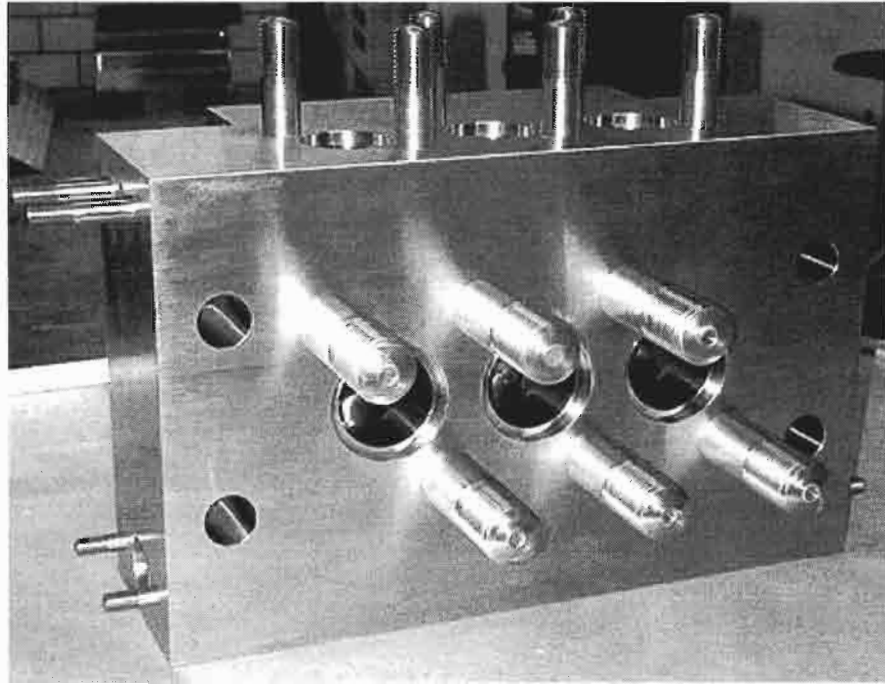

- ***REPLACEMENT CYLINDER BLOCK HEADS MADE TO ORDER
2000 - 8000 PSI***
- ***SUPERIOR MATERIALS, APPLICATION ORIENTED,
PROVIDED WITH A (5) YEAR PRO-RATED WARRANTY***
- ***SHORT LEAD TIMES***
- ***CUSTOM ENGINEERED FOR VARIED PORT LOCATION***
- ***COMPETITIVELY PRICED SUPERIOR QUALITY BLOCKS***
- ***DELIVERED WITH OR WITHOUT OUR SEATS INSTALLED***
- ***EACH JOB QUOTED UPON REQUEST***